



TRIM CATALOG

Go Custom

Modify a standard trim or order a completely custom profile to get the best results.

Please take note:

Standard length is 10'-2"
All profiles available in 29, 26 & 24 Ga.

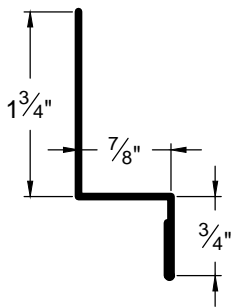

BASE FLASHING
BF-1

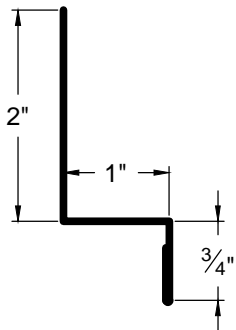

BASE FLASHING
BF-2

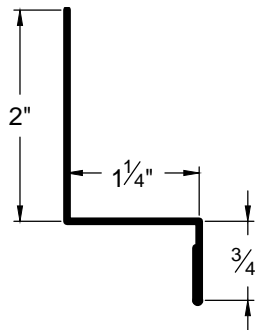

BASE FLASHING
BF-3

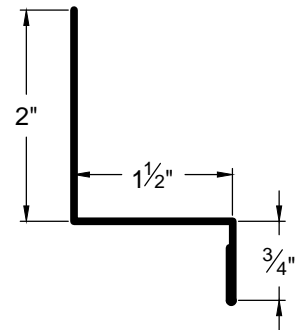

BASE FLASHING
BF-4

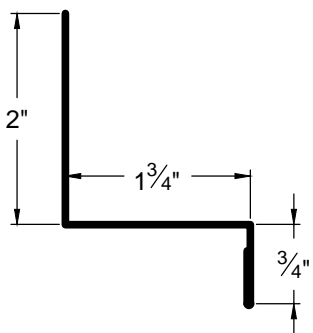

BASE FLASHING
BF-5

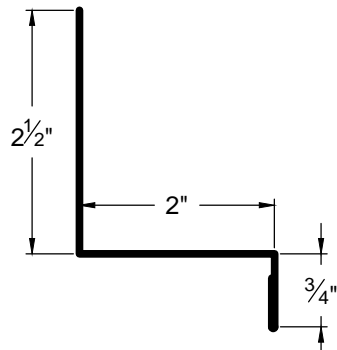

BASE FLASHING
BF-6

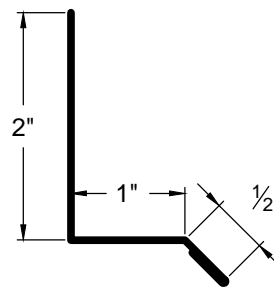

DRIP CAP
DC-1

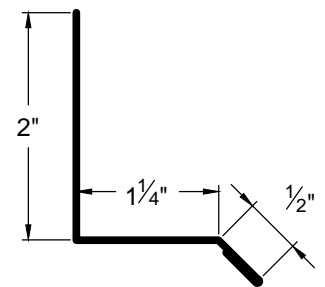

DRIP CAP
DC-2

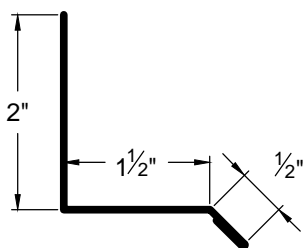

DRIP CAP
DC-3

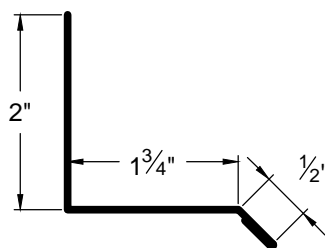

DRIP CAP
DC-4

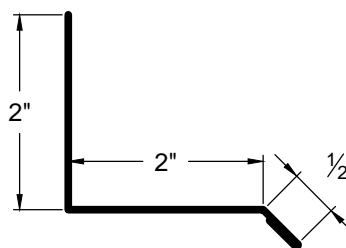

DRIP CAP
DC-5

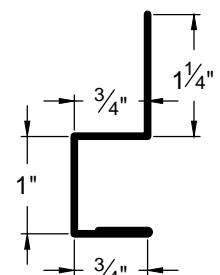

BASE TRIM
BT-1

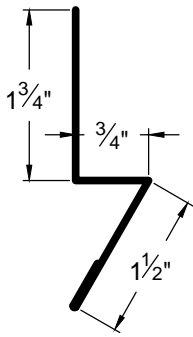

RAT GUARD
RG-1

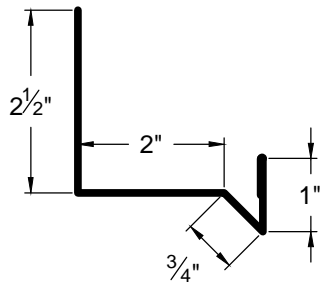

DOOR & WINDOW
DRIP CAP
RG-1

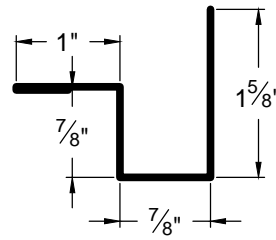

WALL TO CEILING
WC-1

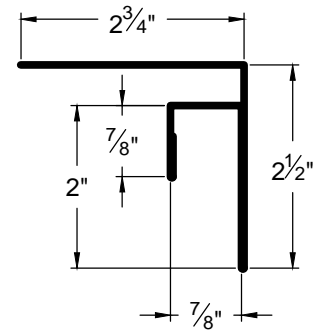

SOFFIT STARTER
ST-1

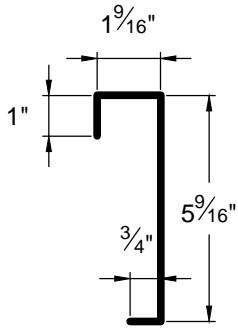

OVERHEAD DOOR CAP
ODC-1

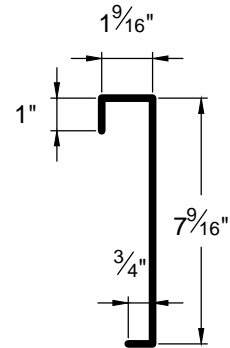

OVERHEAD DOOR CAP
ODC-2

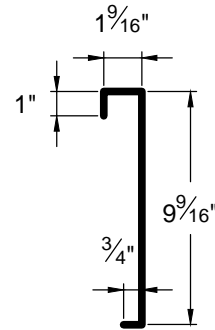

OVERHEAD DOOR CAP
ODC-3

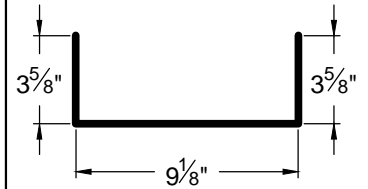

OVERHEAD DOOR CAP
ODC-4

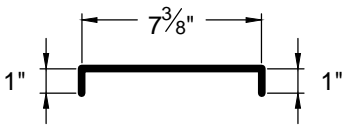

DOOR BACKING
DBC-1

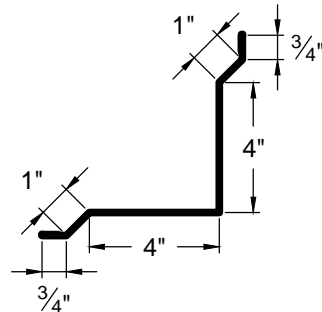

INSIDE CORNER
IC-1

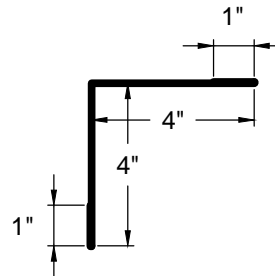

INSIDE CORNER
IC-2

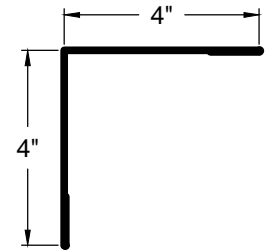

OUTSIDE CORNER
OC-1

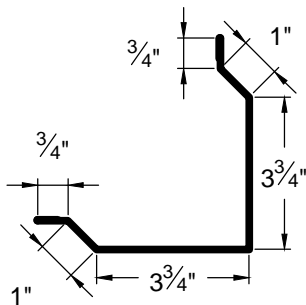

OUTSIDE CORNER
OC-2

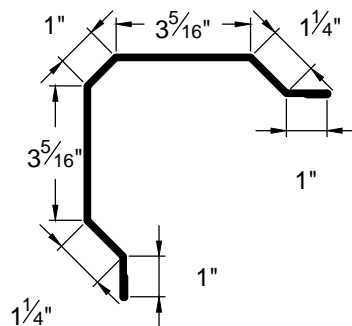

OUTSIDE CORNER
OC-3

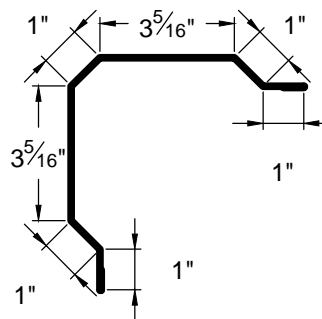

OUTSIDE CORNER
OC-4

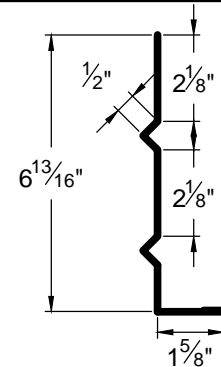

REINFORCED FASCIA
REF-1



324 Cargill Road
Winkler, MB
R6W 0K4

Office: (204) 331-5170
Cell: (204) 332-2445
Fax: (204) 331-5174
Email: jp.irosteel@gmail.com

Go Custom

Modify a standard trim or order a completely custom profile to get the best results.

Please take note:

Standard length is 10'-2"
All profiles available in 29, 26 & 24 Ga.

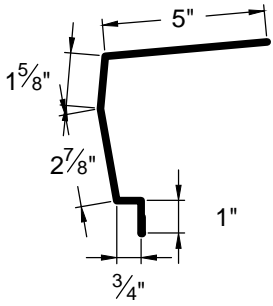

EAVE TRIM (NO GUTTERS)
26-ET-NG

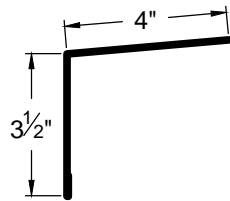

EAVE TRIM (GUTTERS)
26-ET-WG

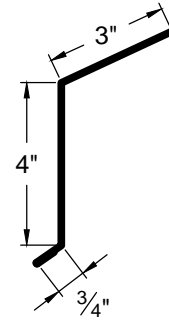

EAVE TRIM
ET-1

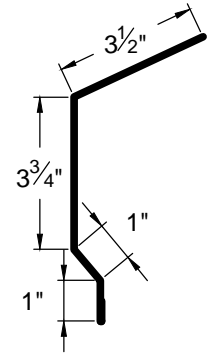

EAVE TRIM
ET-2

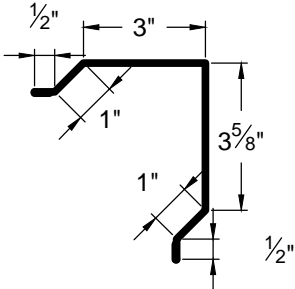

GABLE TRIM
GT-1

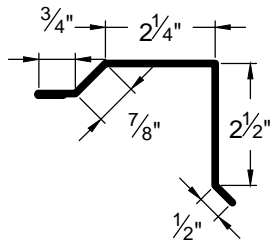

GABLE TRIM
GT-2

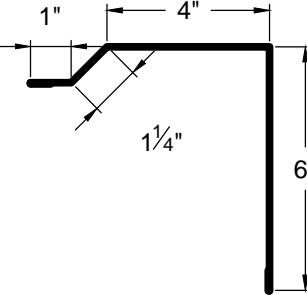

GABLE TRIM
GT-3

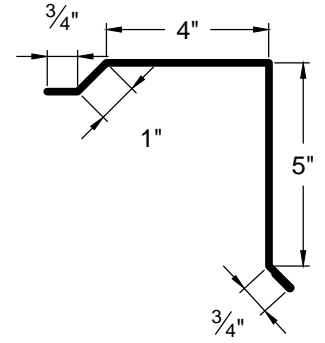

GABLE TRIM
GT-4

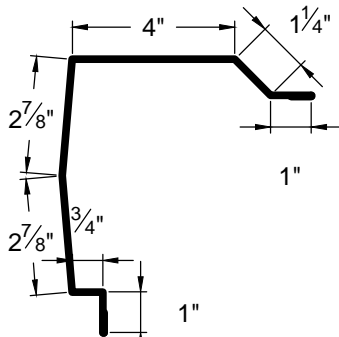

GABLE TRIM
GT-5

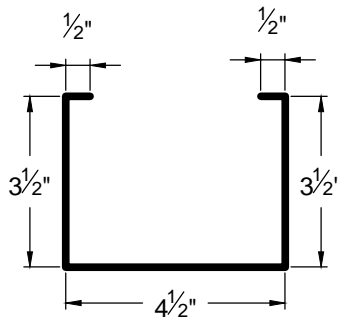

DOWNSPOUT
DS-1

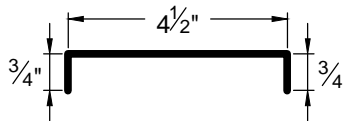

DOWNSPOUT CAP
DSC-1

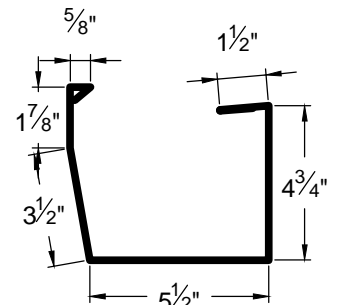

GUTTER
EG-2

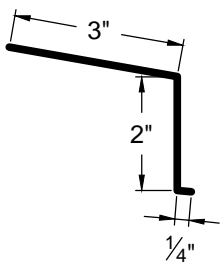

ROOF EDGE
RE-1

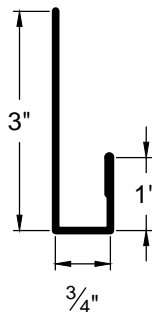

J TRIM
JT-1

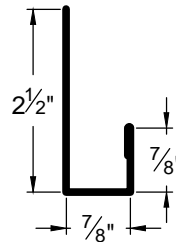

J TRIM
JT-2

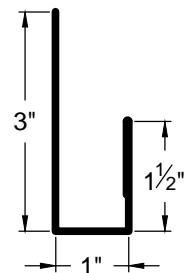

J TRIM
JT-3



324 Cargill Road
Winkler, MB
R6W 0K4

Office: (204) 331-5170
Cell: (204) 332-2445
Fax: (204) 331-5174
Email: jp.irosteel@gmail.com

Go Custom

Modify a standard trim or order a completely custom profile to get the best results.

Please take note:

Standard length is 10'-2"
All profiles available in 29, 26 & 24 Ga.

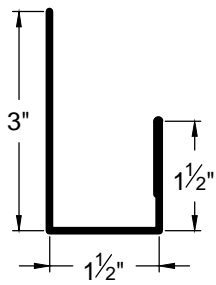

J TRIM
JT-4

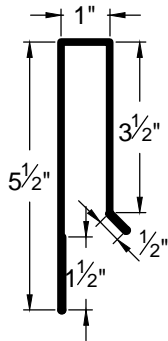

J TRIM
JT-5

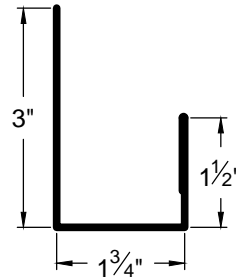

J TRIM
JT-6

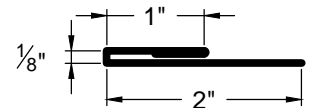

SILL TRIM
ST-2

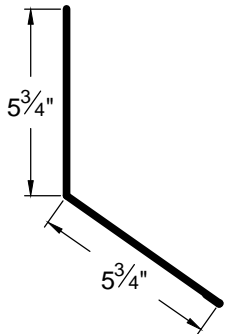

ROOF TO WALL
RTW-1

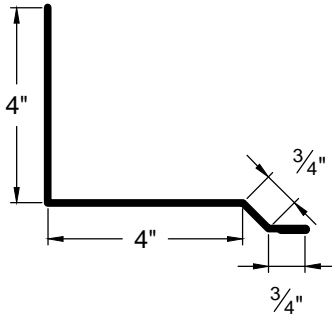

ROOF TO WALL
RTW-2

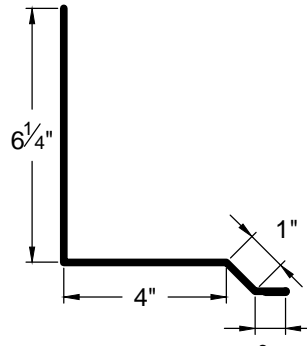

ROOF TO WALL
RTW-3

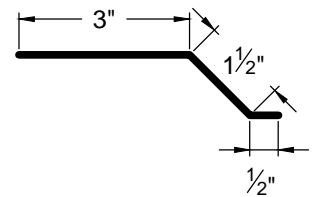

ROOF EDGE FLASHING
RF-1

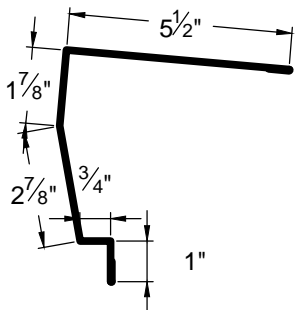

HIGH EAVE
HE-1

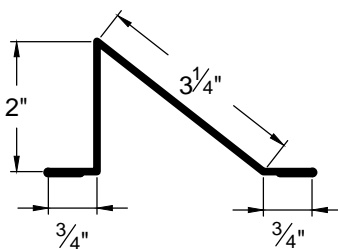

SNOW STOP
SS-1



RIDGE CAP
RC-1

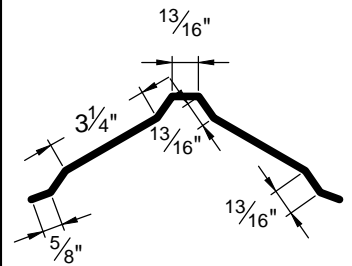

DELUXE RIDGE CAP
RC-2

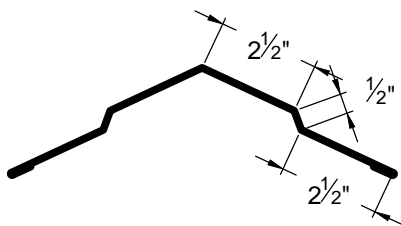

DELUXE RIDGE CAP
RC-3

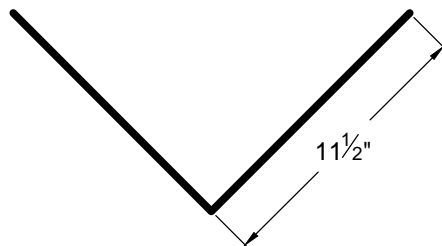

VALLEY FLASHING
VF-1

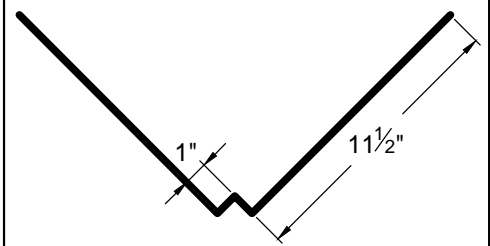

W-VALLEY
VF-2



324 Cargill Road
Winkler, MB
R6W 0K4

Office: (204) 331-5170
Cell: (204) 332-2445
Fax: (204) 331-5174
Email: jp.irosteel@gmail.com

Go Custom

Modify a standard trim or order a completely custom profile to get the best results.

Please take note:

Standard length is 10'-2"
All profiles available in 29, 26 & 24 Ga.